

Fig. 1 Location of the study areas (1-5) on Tertiary calcareous sedimentary rocks (stippled) in western Nelson. (From Drice, Williams and Haine, 1987)

DISTRIBUTION OF TERTIARY CALCAREOUS SEDIMENTARY ROCKS IN NW NELSON BETWEEN KARAMEA AND MATIRI RIVERS

Areas surveyed:

M - Matiri area (S Matiri Ra.)

P - Pike area (Allen Ra.)

G - Garibaldi Ridge area (E of Karamea)

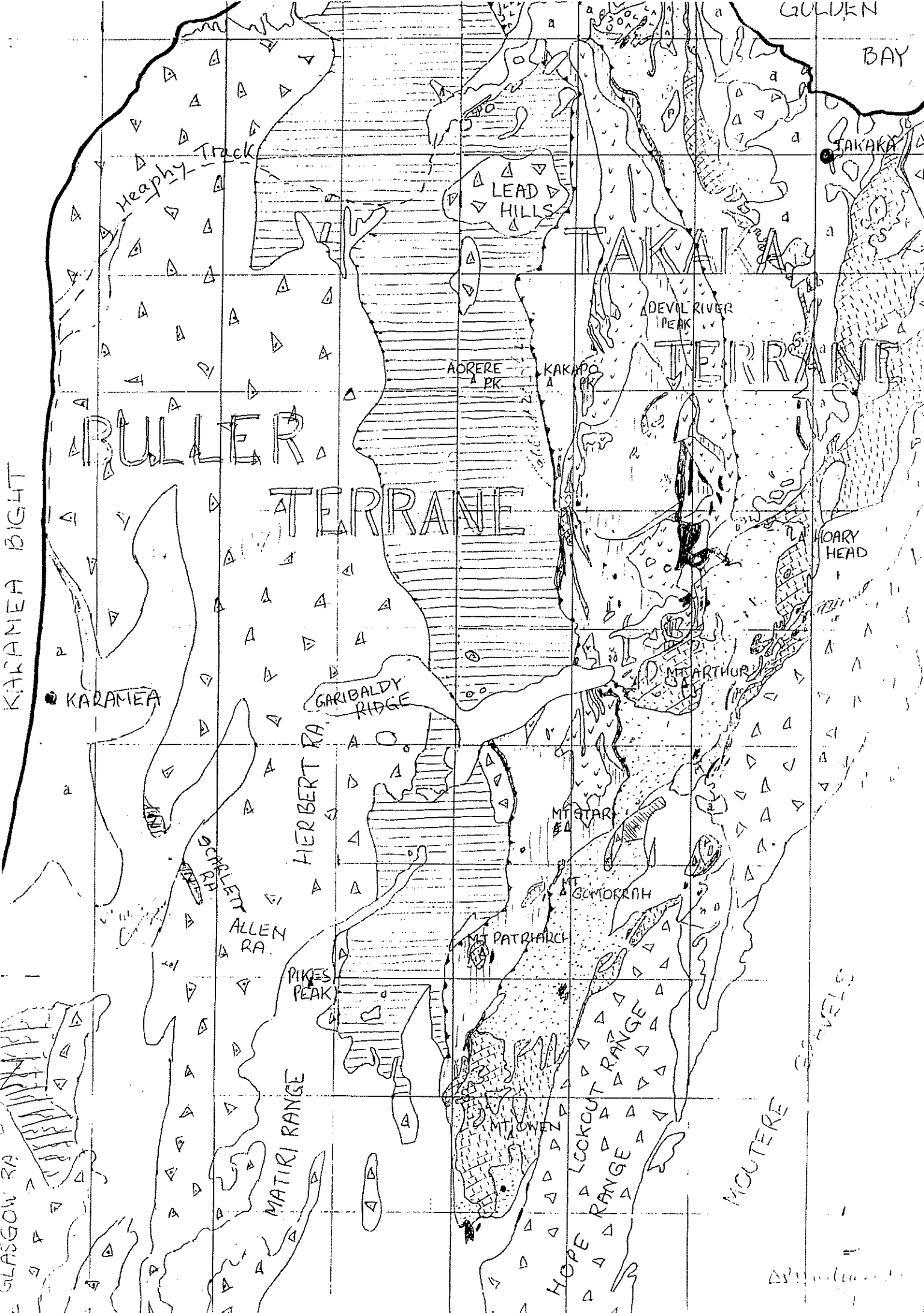

GENERAL LOCATION AND GEOLOGY OF EACH AREA

(Grid refs on Infomap 262-9 are for the centre of each area) (Geology from Grindley 1961, 1980; Coleman 1981)

Area - Location	Geology	Grid ref.
	Tertiary calcareous rocks	
Goulard Downs area (D)	} crystalline lime- stone, sandy lime- stone, calcareous quartz sandstone, calcareous mud- stone	455035
Takaka area (T), upper Takaka V		483004
Matiti area (M), S Matiti Ra.		453960
Pike area (P), Allan Ra.		456973
Garibaldi Ridge area (G), E of Karamea		462997
Bald Knob Ridge area (B), ESE of Mt Owen		463960

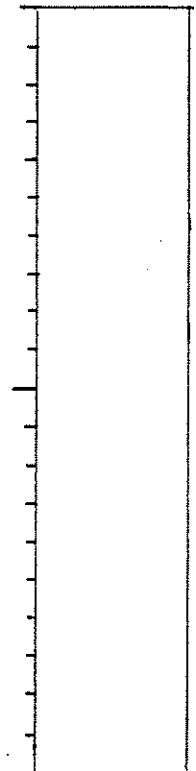
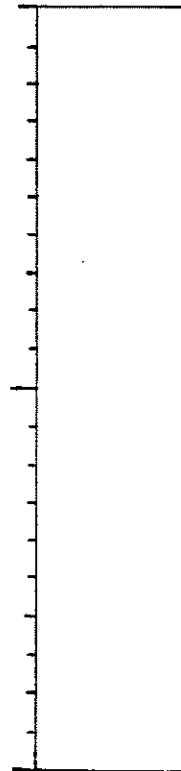
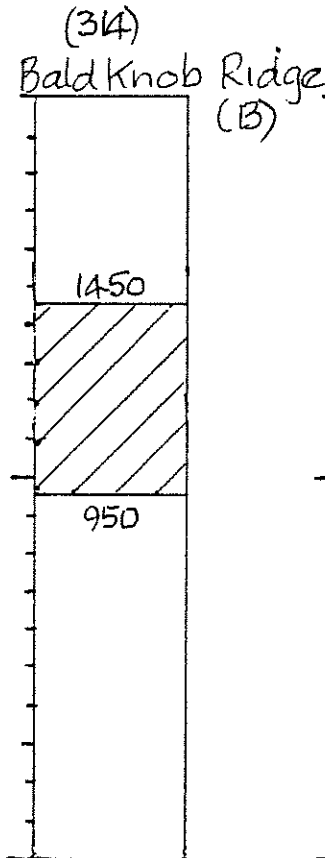
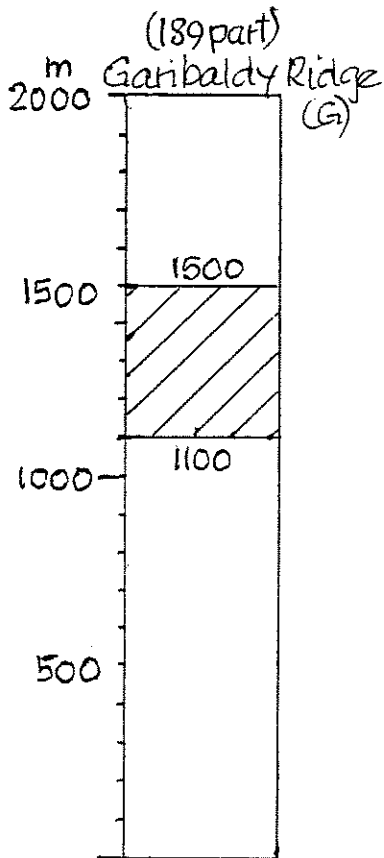
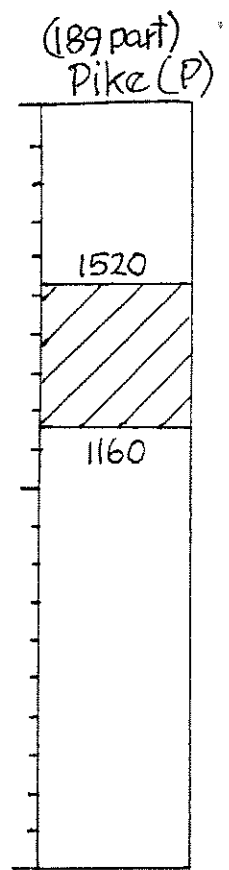
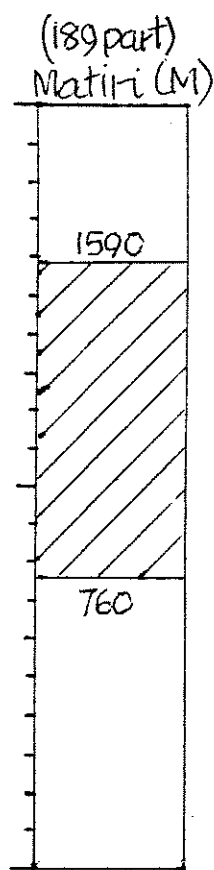
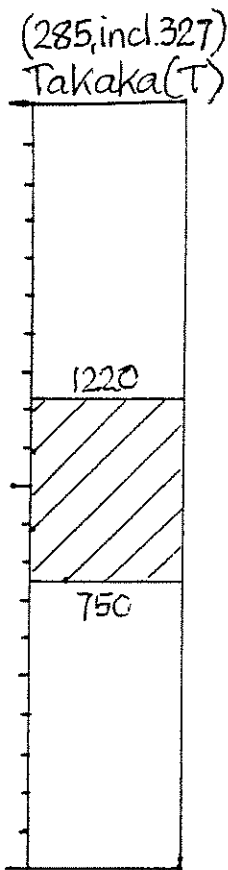
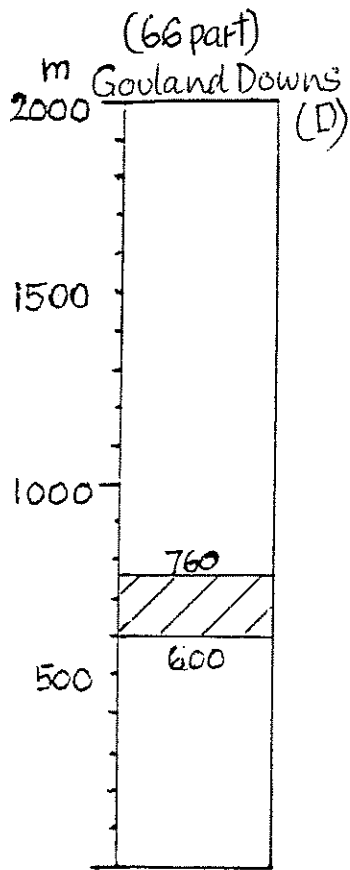

ALTITUDINAL RANGE OVER WHICH PLANTS WERE RECORDED
IN EACH AREA

The numbers in brackets refer to lists of plants compiled for each area and filed at Landcare Research

Field work in the Tertiary calcareous mountains totalled 42 days, mostly between 1979 and 1989. The separate areas were visited at the dates indicated below.

Goulard Downs (D)	3 days in January 1969
	4 days in January 1973
	1 day in March 1992
Takaka (T)	1 day in January 1975
	1 day in April 1986
	2 days in May 1987
	2 days in April 1989
	2 days in December 1991
Matiti (M)	1 day in May 1977
	7 days in February 1979
	7 days in March 1981
	1 day in January 1988
Pike (P)	1 day in February 1982
Garibaldi Ridge (G)	5 days in March 1980
Bald Knob Ridge (B)	4 days in February 1989

The following participated in the field work: Ian Atkinson, Mary Bruce, Warren Burke, Shannel Courtney, Helen Druce, Tony Druce, Victoria Frode, Arnold Heine, Jan Heine, Roland Heine, Bill Malcolm, Geoff Park, Geoff Rogers, Barbara Simpson, Neill Simpson, Barry Snedden, Barry Spring-Rice, Kath Walker, Geoff Walls, Peter Williams, and members of Wellington Botanical Society.

INDIGENOUS PLANTS (457 SPECIES)

GYMNOSPERM TREES AND SHRUBS

- Halocarpus bidwillii (D, unct, M) [Dactyidium bidwillii]
H. biformis (T, M, unct G) [Dactyidium biforme]
Lagarostrobos colensoi (unct T) [Dactyidium colensoi]
Lepidothamnus intermedius (unct M) [Dactyidium intermedium]
L. laxifolius (M, P, G, B) [Dactyidium laxifolium]
L. intermedius x L. laxifolius (unct M)
Libocedrus bidwillii (T, M, unct G)
Phyllocladus alpinus s.s. / P. sp. @ (D, M, G, B)
 P. alpinus s.s. (D, B, distribution elsewhere uncertain)
 P. sp. @ (D, T, distribution elsewhere uncertain) (aff. P. alpinus;
 "lowland" ecotype of Wardle 1969) [P. alpinus in part]
Podocarpus acutifolius (M)
P. hallii (unct T, M)
P. nivalis (unct, unct M, G, B)
P. hallii x P. nivalis (unct, unct M)

DICOTYLEDONOUS TREES AND SHRUBS

- Arctostaphylos traversii s.l. (incl. A. traversii var. australis) (T, M, P, G, B)
Aristotelia fruticosa var. (a) (T, M, G)
A. serrata (unct D, T, unct M)
A. fruticosa x A. serrata (unct, unct M)
Brachyglottis adamsii (unct B) [Senecio adamsii]
B. bidwillii var. vitidis (T, G, B) [Senecio bidwillii var. vitidis]
B. greyi var. (a) (incl. B. laxifolia) (M) [Senecio greyi]
B. hectorii (unct T, unct M, unct G) [Senecio hectorii]
B. rotundifolia var. (a) (incl. B. buchananii and B. cockaynei)
 (unct T, unct M, unct G, B) [Senecio bennettii]
B. bidwillii x B. rotundifolia (unct G)

- Carpodetos serratus (D, T, unc M)
Cassinia vauvilliersii (D, M, G, B)
Coprosma atropurpurea (M, G, B) [C. patrici var. atropurpurea]
C. cheesemani s.s. (T, M, P, G, B)
C. ciliata ssp. ciliata (T, M, P, G, B)
C. colensoi s.s. (D, T, M, P, unc G, B) [C. banksii and C. colensoi]
C. cranulata (unc M, G, unc B)
C. depressa (T, M, P, G, B)
C. foetidissima (T, M, P, G, B)
C. linatifolia (D, T, unc M)
C. lucida s.s. (D, unc T)
C. perpusilla ssp. perpusilla (M, P, G, B) [C. pumila in part]
C. propinqua ssp. propinqua (D, T, M, unc P, G, B)
C. pseudocuneata ssp. (a) (D, T, M, P, G, B) (lvs narrower than in ssp. pseudocuneata)
C. rhamnoides s.l. (incl. C. polymorpha) (D, unc T, unc M, unc G, unc B)
C. rigida (unc M)
C. rugosa ssp. rugosa (D, T, M, P, G, B)
C. serrulata (M, G, B)
C. sp. (a) (D, unc T, M, B) (described as C. parviflora var. dumosa by Cheeseman 1906, non C. parviflora var. dumosa sensu Allan 1961; lf undersurface not minutely hairy as is usual in C. parviflora; droopes usually unpigmented, occasionally purplish red) [C. parviflora in part]
C. sp. (b) (T, M, G, B) (C. parviflora var. dumosa sensu Allan 1961)
C. sp. (c) (unc M) (aff. C. intertexta; prostrate or lianoid shrubs)
C. sp. (d) (unc P, unc G, B) (aff. C. pseudocuneata; low-growing shrubs with small thick arcuate lvs) [C. pseudocuneata in part]
C. sp. (e) (unc T, unc G) (aff. C. colensoi; low-growing shrubs with trailing branches) [C. colensoi in part]
C. cheesemani X C. ciliata (unc M)
C. propinqua X C. robusta (unc T, unc M)

- Coriaria plumosa (M, P, unc G, B)
C. sarmentosa (T, M, unc P, unc G, B)
C. plumosa X C. sarmentosa (unc M, unc G)
Cyathodes dealbata (M, P, G, B) [C. pumila]
C. campetifolia (T, M, P, G, B)
C. sp. (a) (D, T) (C. juniperina agg.; lvs small, usually < 1cm X < 1mm)
Dracophyllum longifolium var. (a) (incl. D. filifolium and D. oliveri) (D, T, M, P, G, B)
D. palustre (M)
D. politum s.l. (incl. D. deusum) (unc G)
D. pubescens var. pubescens (G)
D. townsonii (D)
D. traversii s.l. (incl. D. pyramidale) (T, M, P, G, B)
D. uniflorum (T, unc M, P, G, B)
D. sp. (a) (unc M) (aff. D. kirkii; low-growing shrubs; branches often rooting; lf blade up to 2mm wide near sheath, slightly glaucous, very minutely scabrid; lf margins minutely serrulate; infl of few-flowered racemes)
D. longifolium X D. palustre (M)
D. longifolium X D. uniflorum (unc M)
Elaeocarpus hookerianus (T, unc M)
Excoecarpus bidwillii (D)
Fuchsia excorticata (T, unc M)
Gaultheria antipoda (T, M)
G. crassa (G, B)
G. depressa s.s. (M, P, G, B)
G. macrostigma (M) [Pernettya macrostigma]
G. tupestis s.l. (incl. G. subcorymbosa) (D, unc G)
G. sp. (a) (T, M, P, G, B) (described as G. depressa var. novae-zelandiae by Franklin 1962) [G. depressa in part]
G. crassa X G. sp. (a) (B)
Griselinia littoralis (D, T, M, P, G, B)

- Hebe albicans var. albicans (G)
H. cauterburcensis (T, M, P, G, B)
H. ciliolata (B)
H. gracillima (D, T, M, unc G, unc B)
H. haastii var. (a) (M, P, G) (aff. var. humilis; see Moore 1961, p. 940)
H. macrantha var. brachyphylla (M, P, G, B)
H. odora s.s. (T, M)
H. pauciramosa s.s. (M, P, B)
H. salicifolia var. salicifolia (M, unc G, B)
H. tetragona var. (a) (incl. H. coarctata) (T, unc M, G, B)
H. topiaria (T, M, P, G, B)
H. vermicosa (T, B)
H. sp. (a) (incl. Leonohebe masoniae (T, M, B) [Hebe pauciramosa var. masoniae])
H. sp. (b) (incl. Leonohebe mooreae) (G) [Hebe odora in part]
H. sp. (j) (T) (multi-branched shrubs; lvs to 4x1 cm, elliptic-oblong, bright green, upper surface very glossy, margins very minutely serrate; margins of calyx lobes densely ciliate; corolla tube very short, = or < calyx; corolla lobes obtuse; capsule pubescent)
H. sp. (n) (unc B) (aff. H. matthewsii)
H. sp. (t) (D, T, unc B) (aff. H. glaucophylla)
H. sp. (undetermined) (unc T)
Helichrysum aggregatum var. aggregatum (T) [H. glomeratum]
H. intermedium var. (a) (T, M, P, G, B) [H. selago var. intermedium in part]
H. intermedium X Raoulia sp. (undetermined) (unc M)
Hohemia lyallii var. (incl. H. glabrata) (T)
Leptospermum scoparium (D, T, M)
Leucopogon fasciculatus var. (a) (T, unc M) (juvenile lvs not much broader than adult lvs) [Cyathodes fasciculata]
L. fraseri s.s. (D, T, M, P, G, B) [C. fraseri]
Melicytus obovatus var. obovatus (unc T)
M. sp. (a) (unc M, unc G) (prostrate hermaphrodite shrubs; branches up to 40cm long, often rooting; lvs linear-oblong; fl white)

M. sp. (♀) (D, T, M, P, G, B) (aff. M. alpinus; shrubs taller than in M. alpinus, upto 2.4 m; spiny shoots point in all directions with average branch angle of c. 70°, whereas in M. alpinus they tend to point in one direction with an average branch angle of c. 50°; lvs broader than in M. alpinus) [Hymenanthera alpina in part]

Metrosideros umbellata (D, T, M, G)

Myrsine divaricata ss. (D, T, M, P, G, B)

M. nummularia (M, P, G, unc B)

Neomyrtus pedunculata (T, unc M)

Nolthofagus fusca (D, T, M, B)

N. manziesii (D, T, M, P, G, B)

N. solandri var. cliffortioides (T, M, B)

N. fusca × N. solandri (unc B)

Olea arborescens (D, T, M, unc G, B)

O. avicennifolia (unc D, T, M, unc P, G, B)

O. colensoi var. colensoi (M, G)

O. lacunosa var. lacunosa (unc D, M, P, G, B)

O. nummularifolia var. (a) (unc T, unc M, unc G, unc B) (lvs oval, rather than suborbicular as in var. nummularifolia)

O. virgata var. implicita sl. (incl. O. virgata var. divaricata and O. virgata var. laxiflora) (T, M)

O. arborescens × O. lacunosa (unc M)

O. avicennifolia × O. nummularifolia (unc M, unc G)

O. capillaris × O. lacunosa (unc T)

Pentachondra pumila (T, M, P, G, B)

Petaxilla tetrapetala (unc M) [Elytranthe tetrapetala]

Pimelea longifolia (M, G)

P. oreophila (T, M, P, G, B) [P. pseudolyallii in part]

P. prostrata (unc M)

Pittosperum anomalum (D, M)

P. rigidum var. (a) (incl. P. crassicaule) (T, M, P, G, B)

P. tenuifolium (T, unc M)

Pseudopanax anomalus (D, T, M, B) [Neopanax anomalum]
P. colensoi s.s. (unc D) [Neopanax colensoi]
P. crassifolius (D, T, unc M)
P. linearis (D, unc T, M, unc G, unc B)
P. macintyreii (D, T)
P. simplex s.l. (incl. P. simplex var. sinclairii) (T, M, unc P, unc G, B)
 [Neopanax simplex]
P. sp. (a) (T, M, unc P, G, B) (described as P. colensoi var. ternatum
 by Wadde 1968) [Neopanax colensoi in part]
Pseudowintera colorata (T, M, unc P, B)
Quintinia serrata s.l. (incl. Q. acutifolia and Q. elliptica) (D, M)
Schefflera digitata (unc T)
Traversia baccharoides (T, M, G, B)
Urtica fetox (unc T)
Weinmannia racemosa var. racemosa (T)

DICOTYLEDONOUS LIANES AND RELATED TRAILING PLANTS

Clematis forsteri (unc M) [C. australis, C. forsteri, C. hookeriana,
 and C. petriei]
C. paniculata (D, unc M, unc B)
Muehlenbeckia australis (T, M)
M. axillaris (T, M, P, G, B)
M. australis x M. axillaris (unc T, unc M)
Rubus cissoides var. (a) (T, M, B) ("form c" of Allan 1961; flts
 broader than in var. cissoides)
R. schmidelioides var. schmidelioides (D, T, M, unc G, unc B)
R. cissoides x R. schmidelioides (unc M)

LYCOPODS

Lycopodium australianum (T, unc M, unc P, G, B)
L. fastigiatum (T, M, P, G, B)

L. scariosum (unc T, M, P, G, B)

L. varium (unc P, unc G)

FERNS

Adiantum cunninghamii (T)

Asplenium bulbiferum (M, unc T)

A. flaccidum (T, M, G, B)

A. gracillimum (T) [A. bulbiferum ssp. gracillimum]

A. hookerianum (T)

A. lyallii (D, T)

A. oblongifolium (D, T)

A. terrestre ssp. terrestre (unc D)

A. sp. a (T) (A. trichomanes agg.)

Blechnum chambersii (D, T, unc M, unc G)

B. colensoi (D, unc M)

B. discolor (T, M, unc P, G, B)

B. fluviatile agg. (D, T, M, P, G, B)

B. membranaceum (D, T)

B. penna-marina (D, T, M, P, G, B)

B. procerum (T, M, P, G, B)

B. vulcanicum (T)

B. sp. a (T, unc M, unc G) (lowland sp.; lower pinnae reduced in length) [B. sp. 1]

B. sp. b (M, P, G, B) (mountain sp.; lower pinnae not reduced in length; "The Dunedin-Cass Variety" of Crookes 1963)

[B. sp. 3]

Ctenopteris heterophylla (D, T)

Cyathea colensoi (T, M, P, G, B)

Cystopteris tasmanica (D, T, M, P, G, unc B)

Gleichenia dicarpa (M)

Grammitis billardierei (D, T, M, P, G, B)

G. magellanica ssp. nothofagati (T, M, G, B)

G. patagonica (D, T, M, P, G, unc B)

G. poeppigiana (M, P, G, B)

Histiopteris incisa (T, unc M, unc P, unc B)

Hymenophyllum demissum (D, unc T, unc M)

H. flabellatum (D)

H. malinqii (unc M, unc P, unc B)

H. multifidum (D, T, M, unc P, G, B)

H. pulcherrimum (unc D, unc M)

H. rarum (unc T, unc M, unc B)

H. rufescens (D, M, unc P, unc G)

H. villosum (T, M, P, G, B)

Hypolepis millefolium (D, T, M, P, G, B)

H. rufobarbata (unc M)

Leptopteris superba (unc T, M, P, unc G, B)

Ophioglossum coriaceum ags. (unc M, unc P, unc G, B)

Paesia seabertula (unc T)

Phymatosorus pustulatus (T) [P. diversifolius]

Pneumatopteris pannigera (D, T, unc M)

Polystichum richardii (unc T)

P. vestitum (D, T, M, P, G, B)

Pyrosia eleagnifolia (T)

Schizaea australis (unc M)

Trichomanes reniforme (D)

MONOCOTYLEDONOUS HERBS

ORCHIDS

Adenoclinus gracilis (unc M, B)

Aperostylis bifolia (T, M, P, G)

Chiloglottis cornuta (unc M, P, unc G, B)

Corybas macranthus (T, M, P, unc G, B)

C. hirsutis s.s. (D, unc M) [C. orbiculatus]

C. trilobus s.s. (D, T, M, G, B)

Gastrodia cunninghamii (unc M)

G. sesamoides (unc D)

Lyperanthus antarcticus (unc G)

Microtis oligantha (unc D, unc M, unc G)

M. unifolia (unc M, B)

Prasophyllum colensei (D, M, P, G, unc B)

Pterostylis australis (D)

P. humilis (unc B)

P. itsenharae (unc D, unc M, unc P, unc G, unc B)

P. oliveri (unc T, unc M, unc G)

P. venosa (unc M, unc G)

Thalymitra hatchii (unc M, unc B)

GRASSES

Agrostis dyeri s.s. (M, P, G, B)

A. muscosa (M)

A. personata (M, P, G, B)

A. sp. (b) (G, B) (aff. A. dyeri but panicle not contracted)

[A. dyeri in part]

Chionochloa australis (T, M, G, B) [Danthonia australis]

C. cheesemani (unc T) [Danthonia raoulii var. cheesemani]

C. conspicua ssp. conspicua (D, T, M, P, G, B) [Danthonia cunninghamii]

C. pallens ssp. pallens (T, M, P, G, B) [Danthonia raoulii in part]

C. rubra ssp. occulta (T, M, P, G, B) [Danthonia raoulii in part]

C. sp. (a) (M, P, G, B) (C. flavescens auct. South Island, non C. flavescens Zotov; lf blade green on abaxial surface, glabrous on adaxial surface, wide, strap-like, without midrib, or with faint midrib on abaxial surface only) [Danthonia raoulii var. flavescens in part]

C. conspicua X C. pallens (unc M, unc G)

C. conspicua X C. rubra (unc M)

- C. conspicua x C. sp. (a) (unc M)
C. pallens x C. tubra (M, P, G)
C. pallens x C. sp. (a) (unc B)
C. tubra x C. sp. (a) (M, P, G)
Deschampsia caespitosa (unc M)
D. novae-zelandiae (incl. D. chapmanii?) (M, unc P, G)
D. tenella (D, T, M, P, B)
Deyeuxia Aucklandica (M, unc G, unc B) [D. setifolia]
D. avenoides s.l. (incl. D. avenoides var. bradyantha) (M)
Elymus enysii (M, P, B) [Agropyron aristatum]
E. sp. (a) (T, M, P, G, B) (aff. E. rectisetus; plants usually glaucous;
 lf blade usually flat, up to 5mm wide; awns 4-6cm long)
 var. (a) (culms erect or ascending) [Agropyron scabrum in part]
Festuca sp. (a) (unc M, unc B) (slender, tufted, green or glaucous-
 green plants with setaceous lvs) [F. tubra in part]
F. sp. (b) (T, M, P, G, B) (aff. F. matthewsii; plants tufted but not
 tussock-forming)
Microchloa novae-zelandiae (unc M, P, G, unc B) [H. fraseri in part]
Koeleria sp. (a) (M, G) (K. novozelandica agg.; plants rhizomatous;
 lvs narrow, channelled) [K. kurtzii in part]
Lachnagrastis lyallii s.l. (incl. L. filiformis var. semiglabra)
 (D, T, M, P, G, B) [Deyeuxia forsteri var. semiglabra]
Microlaena avenacea (D, T, M, P, G, B)
M. colensoi s.s. (T, M, P, G, B) [Ehrharta colensoi]
Poa breviglumis (T, M, P, G, B) [P. imbecilla var. breviglumis]
P. calsa (unc M, unc G) [P. kirkii in part]
P. cita ssp. cita (T, M, G) [P. caespitosa]
P. colensoi (D, T, M, P, G, B)
P. imbecilla (unc D, T)
P. kirkii (unc M, unc P, G, B)
P. maia (unc M, P, unc G, B)
P. pusilla (T) [P. pusilla and P. seticulmis]
P. subvestita (M, P, G) [P. novae-zelandiae var. subvestita]

P. sudicola (M, unc P)

P. sp. (c) (unc P, unc G) (aff. P. novae-zelandiae; sedge plants with narrow lvs) [P. novae-zelandiae in part]

Rytidosperma australe (unc M) [Tricodia australis]

R. buchananii (T, M) [Danthonia buchananii]

R. gracile (D, T, M, P, G, B) [Danthonia semiannularis in part]

R. nigricans (M, P, G) [Danthonia semiannularis var. nigricans]

R. setifolium (T, M, P, G, B) [Danthonia semiannularis var. setifolia]

Simplicia buchananii (unc D, unc T)

Trisetum youngii (M, P, unc G, B)

T. sp. (a) (D, T, M, P, G, B) (plants slender; lf sheath glabrous or nearly so; lf blade flat, up to 2.5 mm wide, margins smooth, usually with a few hairs near ligule) [T. antarcticum in part]

T. sp. (b) (unc M, P, unc G, B) (described as T. antarcticum ssp. tenellum by Petrie 1912) [T. antarcticum var. tenellum]

T. sp. (c) (T, M, P, unc B) (aff. T. antarcticum; plants robust; lf sheath glabrous at least in upper part; lf blade flat, up to 7 mm wide, margins scabrid, usually with some hairs near ligule) [T. antarcticum in part]

T. suspected hybrids between T. youngii, T. sp. (b), and T. sp. (c) (M, P)

SEDGES

Carex acicularis s.l. (incl. C. allanii) (M, P, unc G)

C. breviculmis (T, M, unc G)

C. buchananii (unc M)

C. comans (T, unc B)

C. dallii (unc M)

C. dipsacea var. dipsacea (M, unc B)

C. dissita s.s. (T, M)

C. echinata (M, unc G)

C. enysii (unc M)

- C. flagellifera (unc M, unc B)
C. flaviformis (T, M, G)
C. forstarii (T)
C. gaudichaudiana (T, M, G)
C. inversa (unc M)
C. kirkii s.l. (incl. C. kirkii var. elaticor) (M)
C. lessoniana (D)
C. libera (T, M, G, unc B)
C. secta s.s. (M, unc B)
C. sinclairii (T, M, P, G, unc B)
C. solandri (unc M)
C. testacea s.s. (unc G)
C. trachycarpa (unc P, unc B)
C. wakatipu s.s. (B)
- C. sp. (a) (T, unc M, unc P) (aff. C. testacea but lvs broader, usually reddish, and utricle margins not scabrid) [C. testacea in part]
- C. sp. (b) (D, T, M, unc P, G) (tufts up to 30cm tall; lvs channelled, green to brownish green, usually recurved; spikes 3-5, approximate in small plants, slightly spaced in larger ones; utricles faintly nerved, narrowed gradually to a shallowly bifid beak; stigmas 3)
- C. sp. (c) (M, P, G) (tufts up to 30cm tall in open, occasionally up to 90cm in partial shade; lvs channelled, green, stiff, erect; spikes 3-6, approximate in small plants, distant in large ones; utricles nerved, narrowed abruptly to a shortly bifid beak, stigmas 3)
- C. sp. (d) (T, M, P, G, B) (aff. C. coriacea but lvs slender, bright green, not becoming stiff and yellow-green in exposed sites; utricles similar to those of C. coriacea, faintly to obscurely nerved; beak minute or absent) [C. gaminata in part]
- C. sp. (e) (unc D) (aff. C. dissita but much smaller)

Carpha alpina s.s. (M, P, G, B)
Fleocharis acuta (M, unc P, unc B)
F. gracilis (unc T)
Gahnia procera (T, M, unc P, unc G, unc B)
Isolopis aucklandica (T, M, unc P, unc G) [Scirpus aucklandicus]
I. caligenis (unc M, unc P, unc G) [Scirpus caligenis]
I. habra (D, T, M, P, unc G, unc B) [Scirpus habrus]
I. subtilissima (unc T, M) [Scirpus subtilissimus]
Oreobolus impar (G)
O. pectinatus (M, P, G, B)
O. strictus (T, M, P, G, B)
Schoenus pauciflorus s.s. (T, M, P, G, B)
Uncinia astonii (T, M, P, G, B)
U. caespitosa (T, B)
U. clavata (T, unc M, unc G, B)
U. divaricata (T, M, P, G, B)
U. egmontiana (M)
U. ferruginea (unc M)
U. filiformis (T, M, P, G, B)
U. fuscovaginata var. (a) (D, T, M, P, G, B) (plants glaucous)
U. gracilanta (M, B)
U. involuta (M, P, G, B)
U. longifructus (unc P, unc G)
U. nervosa s.s. (unc M, unc P, G, B)
U. rubra (D, T, M)
U. rupestris s.l. (incl. U. angustifolia) (T, M, P, G, B)
U. silvestris s.l. (incl. U. affinis) (unc P, B)
U. uncinata (D, T, M)
U. zotavii (T, M)
U. sp. (a) (unc M) (aff. U. nervosa but plants more slender; see Edgar 1970, p. 23) [U. nervosa in part]
U. sp. (undetermined) (T)

RUSHES AND ALLIED PLANTS

Cantolapis ciliata (M, G)

Empodisma minus (T, M, G) [Calorophus minor]

Gaimardia setacea (M, G)

Juncus antarcticus (T, M, P)

J. graggi-florus (T, M, unc B)

J. novae-zelandiae (D, T, M, P, G, B)

J. pusillus (unc T, M)

Luzula decipiens (M)

L. migrata (T, M, P, G, B) [L. banksiana var. migrata]

L. picta s.s. (unc P)

L. rufa s.s. (M, P, G)

L. subclavata (unc P, unc G, unc B) [L. picta var. pallida]

L. sp. (a) (D, M, P, G, B) [L. picta var. limosa]

L. sp. (undetermined) (T) (L. picta agg.)

L. migrata x L. rufa (M, P)

MONOCOTYLEDONOUS HERBS OTHER THAN GRASSES, SEDGES, SEDGES, RUSHES AND ALLIED PLANTS

Arthropodium candidum (D, T)

Astelia graminea (M, G, unc B)

A. linearis s.l. (incl. A. linearis var. novae-zelandiae) (M, P, G, B)

A. nervosa s.s. (T, M, P, G, B)

A. nivicola (T, M, P, G, B)

A. petriei (T, M, P, G, unc B)

A. skottsbergii (M, P, G, B)

A. sp. (a) (T, M, G, B) [A. nivicola var. mariceae]

A. sp. (b) (D, T, M, P, B) (aff. A. nervosa but lvs broader and not conspicuously white adaxially) [A. nervosa in part]

Bulbinella hookeri (T, M, G)

Herpolition novae-zelandiae (M, unc G)

Libertia ixioides (unc T, unc M)

L. peregrinans (T, M, G)

L. pulchella (T, M, unc G, unc B)

Luzuriaga parviflora (T, M, B)

Phormium cookianum (D, T, M, P, G, B)

Potamogeton cheesemanii (unc M)

P. sp. (undetermined) (T)

Triglochin striata (unc D)

DICOTYLEDONOUS HERBS

COMPOSITES

Abrotanella caespitosa (T, M, unc P, G)

A. linearis s.s. (T, M, P, G, B)

Anaphalis sp. (a) (T, M, P, G, B) [Helichrysum ballidioides s.s.]

Brachyglottis lagopus var. (a) (M, P, G, B) (cottony hairs on both surfaces of lf, dense at first, but becoming sparse; the under-surface, though with more tomentum than the upper, at no stage appears white, and may end up almost glabrous)

[Senecio lagopus]

B. sp. (a) (T) (included in B. ballidioides, as var. crassa, by Nordenstam 1978) [Senecio ballidioides in part]

Brachyscome radicata (T, unc M, unc P, unc G, B)

B. sinclairii s.s. (M, G)

Celmisia alpina s.s. (M, G)

C. armstrongii (M, G, B)

C. ballidioides (M, P, G, B)

C. dallii (T, P, G)

C. gibbsii (unc M, G)

C. hieraciifolia ssp. hieraciifolia (B)

- C. incana s.l. (incl. C. discolor) (T, M, P, G, B)
C. laticifolia (G, B)
C. lateralis s.l. (incl. C. lateralis var. villosa) (unc G)
C. montei ssp. (a) (T, M, P, G, B) [C. coriacea var. semicordata]
C. parva (G)
C. petrici (M, P, G, B)
C. sessiliflora (unc M)
C. similis (unc P, G)
C. sinclairii s.l. (incl. C. allanii and C. durietzii) (unc P, B)
C. spectabilis ssp. spectabilis (M, P, G, unc B)
C. traversii (unc T, G)
C. sp. (a) (aff. C. gracilentata; plants tufted; lvs linear to linear-lanceolate, upto 45 x 1.2 cm) ssp. (a) (M, P, G) (upper surface and margins of lf thinly covered in tomentum; lower surface densely covered) [C. gracilentata in part]
C. sp. (b) (unc M, P) (aff. C. gracilentata; plants strongly rhizomatous) [C. gracilentata in part]
C. alpina x C. armstrongii (unc M)
C. armstrongii x C. montei (unc G)
C. armstrongii x C. petrici (unc B)
C. armstrongii x C. spectabilis (unc G, unc B)
C. montei x C. petrici (unc M, unc B)
C. montei x C. traversii (unc G)
C. spectabilis x C. traversii (unc G)
Craspedia minor var. minor (T)
C. sp. (a) (M, P, G) (summer-green plants in wet and dry flushes incl. screes; lvs white or greenish white; both surfaces densely clad in cottony hairs that mat together to form a felt closely appressed to the lf surface; beneath the felt both surfaces are densely clad in minute glandular hairs; fls white) [C. lanata var. elongata]

C. sp. (b) (T, M, P, G, B) (summer-green plants, usually on limestone cliffs or in calcareous soils; lvs green, elliptic-spathulate; both surfaces densely clad in short glandular hairs; midrib with or without long multicellular non-glandular hairs; lf margins \pm faintly white with cottony hairs; fls white)

C. sp. (c) (M, P, G) (summer-green plants in bogs and in moist herbfields and tussock lands; lvs green, lamina narrowing gradually to long petiole; both surfaces clad in long multicellular non-glandular hairs, with or without cottony tips, overtopping short glandular hairs; margins faintly to distinctly white with cottony hairs; fls white)

C. sp. (cd) (G) (evergreen plants on cliffs and rock debris; lvs green, thick and fleshy, \pm broadly obovate-spathulate; upper surface at first densely clad in long multicellular non-glandular hairs; lower surface less hairy; lvs later tending to become glabrous; fls white)

C. (gg) (B) (summer-green plants in carpet-grass and bogs; lvs green, \pm recurved; lamina \pm folded, narrowing abruptly to long slender petiole; both surfaces clad in long multicellular non-glandular hairs, with or without cottony tips, overtopping short glandular hairs; margins \pm faintly white with cottony hairs; fls white)

- Dolichoglottis lyallii (M, B) [Senecio lyallii]
D. scorzonetoides (unc G) [Senecio scorzonetoides]
Gnaphalium audax (T, unc M, B) [G. collinum in part]
G. delicatum (unc T) [G. collinum in part]
G. ensifer (M) [G. collinum in part]
G. laterale (T, B) [G. paludosum in part]
G. limosum s.s. (M) [G. collinum in part]
G. mackayi s.s. (T, unc M, G, B) [G. traversii in part]
G. paludosum s.s. (unc M, unc G)
G. polylopus (T, unc M) [G. paludosum in part]
G. ruahinicum (M, P, G) [G. collinum in part]
G. traversii (T, M)
G. ensifer X G. laterale (unc M)
Helichrysum filicaule (T, M)
Lagenifera cuneata (T, unc M, B)
L. petiolata (D, T, unc M) [L. pomila var. multidentata]
L. pinnatifida (unc B)
L. pomila (D, T, M, unc G, unc B)
L. strangulata (T, M, P, G, B) [L. petiolata]
Leptinella pyrethrifolia agg. (M, P, G, B) [Cotula pyrethrifolia]
L. sp. (b) (D, T, M, P, G, B) (included in L. squalida, as ssp. media, by Lloyd and Webb, 1987) [Cotula squalida in part]
Leucogonias grandiceps (unc B)
Microseris scapigera (T, M, P, G, B)
Pseudognaphalium sp. (a) (D, T, M, unc B) (aff. P. luteoalbum; lvs mostly linear-spathulate to linear, acute) [Gnaphalium luteoalbum in part]
P. sp. (b) (T, M, G) (aff. P. luteoalbum; lvs mostly oblong-spathulate to narrow oblong, rounded) [Gnaphalium luteoalbum in part]
Raoulia apicenigra s.s. (M, unc G) [R. hookeri var. apicenigra in part]
R. glabra (T, unc M, P, G, B)

R. grandiflora var. grandiflora (M, P, G, B)

R. tenuicaulis s.l. (incl. R. tenuicaulis var. dimorpha and R. tenuicaulis var. pusilla) (M, B)

Senecio glaucophyllus ssp. glaucophyllus (D, T, unc M, P, unc G, B)

S. rufiglandulosus var. rufiglandulosus (unc M) [S. solandri var. rufiglandulosus]

S. wairauensis (D, T, M, P, G, B) [Erechtites wairauensis]

Sonchus kirkii (unc D) (Druce and Simpson, 1974, as S. littoralis)

Taraxacum magellanicum (T, M, P, G, B)

DICOTYLEDONOUS HERBS OTHER THAN COMPOSITES

Acaena anserinifolia (D, T, M, unc G, B) [A. anserinifolia, A. pusilla, A. pusilla var. suprasericascens, and A. vitidior]

A. fissistipula (M, unc G)

A. inermis (M) [A. inermis, A. microphylla var. robusta, and A. microphylla var. pallideolivacea]

A. profundeincisa (T, M, P, G, B) [A. anserinifolia var. sericeinifolia and A. anserinifolia var. paucidentis]

A. anserinifolia X A. inermis (unc M)

Aciphylla anomala (unc M, P, G, B)

A. colensei var. colensei (M, P, unc G, B)

A. ferox (M, P, G, B)

A. glaucescens s.s. (G)

A. polita var. (a) (G) (If segments coarser than in var. polita and stipules mostly simple; see Dawson and Le Comte, 1978)

A. sp. (c) (T) (aff. A. glaucescens but pinnæ very rigid)

A. anomala X A. colensei (unc M, unc P)

Actinotes novaezelandiae (unc M, unc G) [Hemiphysa suffocata var. novaezelandiae]

Anemone tenuicaulis (M, P, G, B)

Anisotome aromatica (T, M, P, G, B) [A. aromatica vars. aromatica, flabellifolia, incisa, major, obtusata, and pinnatisecta]

A. deltoidea (unc M, unc G)

- A. filifolia (unc M, B)
A. haastii (G, B)
A. pilifera (unc T, M, P, G, B)
A. sp. (a) (unc M) (plants rhizomatous but not usually forming dense mats; pinnæ without hair-tip or with only a short one; infls up to 5cm, not hidden amongst the lvs)
A. pilifera x Aciphylla sp. (undetermined) (unc M)
Cardamine sp. (a) (T, M) (aff. C. corymbosa; plants slender; fls petalous or apetalous - petalous 4-6 mm diam.) [C. corymbosa in part]
C. sp. (b) (D, M, G, B) (C. debilis agg.; "Long Style" of Pritchard 1957)
C. sp. (c) (T, M, P, G) (C. debilis agg.; "Narrow Petal" of Pritchard 1957)
C. sp. (d) (T, M) (C. debilis agg.; "Glossy Leaf" of Pritchard 1957)
C. sp. (e) (M, P, B) ("Tussock Race" of Pritchard 1957)
C. sp. (f) (D, T, unc M, unc P, G, B) (lvs mostly simple, occasionally with up to two pairs of pinnules; blades \neq reniform)
C. sp. (undetermined) (unc B) (C. debilis agg.)
Cheesmania latisiliqua (unc T, M, P, G, unc B)
Colobanthus affinis (D, T, M, P, G, B)
C. apetalus s.l. (incl. C. apetalus var. alpinus) (T, B)
C. canaliculatus s.s. (T, G)
C. squarrosus (M, P, G, B)
C. sp. (b) (T) (lvs and sepals strongly acicular; lvs unbordered; sepals 5, broader than lvs, without a thickened midrib)
Crassula multicaulis (M) [Tillaea multicaulis]
C. sinclairii (unc M, unc B) [Tillaea sinclairii]
Donatia novae-zelandiae (M, P, G)
Drosera arcturi (M, P, G, B)
D. spathulata (T, M, G)
D. stenopetala (M, P, unc G)
Epilobium alsinoides s.s. (unc M, B) [E. alsinoides and E. thymifolium]
E. atiplicifolium s.s. (unc B) [E. alsinoides in part and E. novae-zelandiae]

- E. brunnescens s.s. (T, M, P, G) [E. pedunculare var. brunnescens]
E. clotifolium (T, M, P, G, B)
E. cockayneanum (M, P, G, B)
E. glabellum s.s. (T, unc M, unc P, unc G) [E. erubescens and E. glabellum]
E. gracilipes (D, T, M, P, G, B) [E. gracilipes and E. gracilipes var. concinnum]
E. insulare (unc M)
E. komarovianum (T, M, unc G, unc B) [E. nertteroides and E. nertteroides var. minimum]
E. linnæoides (D, T, unc M, unc G)
E. microphyllum (unc M) [E. microphyllum and E. m. var. prostratum]
E. nertteroides (T, M) [E. pedunculare var. viride]
E. nummulariifolium (unc T)
E. pernitans (M, P, G, B)
E. pubens (unc D, T, unc P, unc B) [E. pubens and E. pubens var. strictum]
E. pycnostachyum (M)
E. rotundifolium (T)
E. vetnicosum (T?, M, P, G, B)
E. sp. (a) (T, M, P, G, B) (included in E. brunnescens, as ssp. minutiflorum, by Raven and Englehorn, 1971) [E. pedunculare var. minutiflorum]
Euphrasia cheesemanii (M, P, G, unc B)
E. cockayneana (M)
E. townsonii s.s. (M, P, G, B)
E. zelandica agg. (M, B)
E. sp. (e) (M, P, G) (aff. E. laingii) [E. laingii in part]
E. sp. (f) (G) (aff. E. pettiei; plants tufted, perennial, forming patches up to 20 cm diam.; stems uniformly pubescent; lvs suborbicular to cuneate-obovate, 5-9 toothed, densely glandular-hairy all over, giving the plant a whitish appearance; pedicels equal to or greater than lvs)

- Forstera mackayi (M, G, B)
F. sedifolia s.s. (unc P, unc G)
F. tenella (T, M, P, G, B)
Galium perpusillum ss. (T, M, P, G, B)
G. trilobum (D, unc M) [G. tenuicaule]
Gentiana bellidifolia (G)
G. filipes (T, M, P, G, B)
G. gracilifolia s.l. (incl. G. vernicosa) (M, G)
G. grisebachii (unc M)
G. montana s.l. (incl. G. montana var. stolonifera, G. patula,
 and G. bellidifolia var. pulchella) (T, M, P, G, B)
G. spenceri (unc M, P, unc G)
G. sp. (a) (M, P, B) (aff. G. bellidifolia; plants perennial, forming
 small to large patches; stems decumbent; lvs very glossy,
 folded, tips deflexed; fls large, creamy white) [G. bellidi-
folia in part]
G. sp. (b) (M) (aff. G. montana; plants perennial, forming
 small to large clumps; stems tall, robust, often decum-
 bent at base; basal lvs densely rosulate, in adult
 plants usually placed some distance up the stem, i.e.
 well above ground level; blade usually apiculate; petiole
 shorter than blade; cauline lf pairs (2)-4-10; infl umbelli-
 form)
G. sp. (g) (B) (aff. G. corymbifera, but stems usually multi-
 branched)
G. sp. (undetermined) (B)
Geranium sessiliflorum var. novae-zelandiae (unc M, B)
G. sp. (e) (T, M, P, G, B) (aff. G. microphyllum) [G. microphyllum
 in part]
Geum leiospermum (T, M, P, unc G, unc B)
G. uniflorum (unc G)
G. sp. (a) (M, P, G, B) (G. parviflorum agg; stock short; terminal
 flt about as long as broad; fls up to 13 mm diam.)
 [G. parviflorum in part]

- Gingidia baxterae (D, M) [Anisotome anysii in part]
G. decipiens (T, M, B) [Angelica decipiens]
G. anysii (unc D) (Webb 1977) [Anisotome anysii]
G. montana (T, M, P, G, B) [Angelica montana]
Gonocarpus aggregatus (T, M, unc P, G, unc B) [Haloragis depressa]
G. micranthus ssp. micranthus (D, M, unc G, unc B) [Haloragis micrantha]
Gunnera dentata var. dentata (unc M)
G. prorepens (D) [G. flavida and G. prorepens]
Hydrocotyle elongata (T)
H. heteromaria (unc T, unc M, unc B) [H. americana var. heteromaria]
H. microphylla (T, M)
H. moschata (D, T, M, B)
H. novae-zeelandiae s.s. (unc M)
H. sulcata (M, unc B)
H. sp. (a) var. (a) (T, M, P, G, B) [H. novae-zeelandiae var. montana]
H. sp. (i) (T) (described as H. moschata var. parvifolia by Carse 1928) [H. moschata in part]
Hypericum japonicum agg. (D, unc M, P, B)
Kelleria diaffenbachii (T, M, G) [Drapetes diaffenbachii]
K. laxa (T, M, unc G, B) [Drapetes laxus]
K. multiflora (unc M, P, G, B) [Drapetes multiflorus]
Lilaeopsis tuthiana (unc M)
Limosella lineata agg. (M, unc B)
Liparophyllum gunnii (unc G)
Mazus radicans (unc T, unc M)
Mentha cunninghamii (D, T, M, P)
Mitrasacme novae-zeelandiae (M, G)
Montia fontana s.s. (T, M)
Myosotis brockiei (T)
M. forsteri (unc D, unc T, unc M, G)

M. macrantha (M, unc G, B)

M. petiolata s.s. (unc T)

M. spathulata s.l. (incl. M. spathulata var. radicata) (unc T)

M. traversii s.l. (incl. M. traversii var. cantabrica) (M)

M. venosa (unc D)

M. sp. (b) (T, unc M, unc P, G, B) (M. australis agg.; fls small, white)

M. sp. (c) (unc T, M, unc P, G, B) [M. pygmaea var. drucei]

M. sp. (undetermined) (T)

Mytiophyllum triphyllum (M) [M. elatinooides]

Neopaxia sp. (b) var. (a) (unc T, M, unc P, unc G, B) (described as Claytonia calycina by Colenso 1896) [Claytonia australasica in part]

N. sp. (c) (T) (lvs spatulate, upto 15mm long; fls 6mm diam.; calyx lobes broad, obtuse; corolla lobes rounded, cucullate)

Nertera balfouriana (M)

N. ciliata (M, P, G, B)

N. depressa s.l. (incl. N. cunninghamii) (D, T)

N. setulosa (unc D)

N. sp. (a) (D, T, M, P, G, B) (aff. N. dichondriifolia but hairs present on both surfaces of lf, straight, not hooked) [N. dichondriifolia in part]

Notolthaspi sp. (b) (unc M, G) (N. australe auct. non Thlaspi australe Hook.f.) [N. australe]

Oreomyrrhis colensoi s.s. (incl. O. colensoi var. hispida and O. colensoi var. multifida) (D, T, M, P, G, B)

O. sp. (d) (T, M, P, unc G, B) (aff. O. ramosa) [O. ramosa in part]

Oreostylidium subulatum (M, unc G)

Orisia caespitosa ssp. caespitosa (unc G, B)

O. lactea ssp. lactea (T, M, P, G, B) [O. macrophylla var. lactea]

O. modesta (unc D, unc T)

O. simpsonii (unc G) [O. sessilifolia var. simpsonii]

Oxalis magellanica (D, T, M, P, G, B) [O. lactea]

Parahelbe decora (P) (unc M)

P. linifolia ssp. linifolia (M, G)

P. lyallii (M, P, G, B)

- Phyllachne clavigera s.l. (incl. P. colensoi) (M, P, G)
Plantago lanigera (T, unc P, unc G)
P. novae-zealandiae (T, M, G)
P. raoulii (D, T, M, P, G, B)
P. triandra s.s. (T, M, unc B)
P. uniflora (M, P, G, B)
Potentilla anserinoides (M, unc B)
Pratia angulata agg. (D, T, M, P, G, B)
Psychrophila novae-zealandiae (unc T, M, unc G, B)
Ranunculus altus (B)
R. cheesemani var. cheesemani (unc T, unc M)
R. foliosus (D, T, M, P, G, unc B) [R. foliosus, R. insertus, and
R. porrectus]
R. glabrifolius (unc T) [R. rivularis in part]
R. gracilipes (unc M) [R. gracilipes and R. sinclairii]
R. insignis (T, M, P, G, B) [R. insignis, R. lobulatus, and R.
montoi]
R. membranifolius (T, M, P, G, B) [R. hirtus in part]
R. mitus (P) [R. hirtus in part]
R. reflexus (T) [R. hirtus in part]
R. royi (T) [R. lappaceus in part]
R. simulans (unc T) [R. depressus var. stewartii]
R. verticillatus (T, M, B, G, B) [R. clivalis]
R. sp. (b) (unc G) (plants slender, stoloniferous, forming patches;
lvs small, usually 3-foliolate)
R. sp. (c) (M) (described as R. lappaceus var. macrophyllus by
Kirk 1899) [R. lappaceus in part]
Rotippa palustris (unc M) [R. islandica]
Rumex flexuosus (unc M)
Schizilema colensoi (M)
S. haastii s.s. (M, G, B)
S. nitens (T, M)
S. trifoliolatum (D, T, unc P, unc G)

S. sp. (a) (P, B) (described as S. haastii ssp. cyanopetalum by
Domin 1908) [S. haastii var. cyanopetalum]

Scleranthus brockii (unc D, M, P, G, B)

S. uniflorus (B)

Stackhousia minima (T)

Stellaria decipiens s.l. (incl. S. parviflora) (D, T, M, unc P, G, B)

Tetrachondra hamiltonii (unc M)

Urtica incisa (D, T, M, P, unc G, B)

Utricularia novae-zelandiae (unc M) [U. monanthos and
U. novae-zelandiae]

Viola cunninghamii (T, M, P, G, B)

V. filicaulis (D, T, M, P, G, B)

V. lyallii (D, T, M, G, unc B)

Wahlenbergia albomarginata var. albomarginata s.l. (incl.
W. brockii and W. pygmaea var. laxa) (T, M, P, G, B)

No. of indigenous species listed for each area:

Goulard Downs (D) : 131

Takaka (T) : 318

Matiti (M) : 442

Pike (P) : 236

Garibaldi Ridge (G) : 327

Bald Knob Ridge (B) : 299

ADVENTIVE PLANTS (c. 62 SPECIES)

DICOTYLEDONOUS TREES

Malus X domestica (unc M)

HORSETAILS

Equisetum arvense (unc M)

MONOCOTYLEDONOUS HERBS

GRASSES

- Agrostis capillaris (M, P, unc B)
- A. stolonifera (unc M)
- Anthoxanthum odoratum (unc M)
- Bromus hordeaceus (unc M)
- Dactylis glomerata (unc M, P, unc B)
- Elymus rectisetos s.s. (unc M)
- Festuca arundinacea s.l. (M)
- F. nigrescens (M, unc G, B)
- Glyceria declinata (M)
- Holcus lanatus (M, B)
- Phleum pratense (M, B)
- Poa annua (unc M, unc P, B)
- P. pratensis (unc M, P, B)

SEDGES

- Carex ovalis (M, unc G, B)

RUSHES

- Juncus articulatus (M, P, G, unc B)
- J. bufonius (M, unc B)
- J. conglomeratus (M, unc G, unc B?)
- J. effusus (M, P, unc B)
- J. tenuis (M)

DICOTYLEDONOUS HERBS

COMPOSITES

- Achillea millefolium (unc M)

Bellis perennis (D)

Cirsium arvense (M, unc G, B)

C. vulgare (M, P, unc G, unc B)

Crepis capillaris (unc M, unc B)

Gnaphalium coarctatum (unc B)

Hieracium lapidulum (unc M)

H. pilosella (unc M, B)

H. praecox (unc M)

H. sp. (undetermined) (unc B)

Hypochaeris radicata (M, P, G, B)

Leontodon taraxacoides (M)

Laucastrum vulgare (unc M, unc B)

Mycelis muralis (M, P, G, B)

Senecio jacobaea (unc M, unc B)

S. sylvaticus (unc M)

Sonchus asper (unc M, unc G, unc B)

S. oleraceus (unc M)

Taraxacum officinale s.l. (M, P, G, B)

DICOTYLEDONOUS HERBS OTHER THAN COMPOSITES

Anagallis arvensis (unc B)

Callitriche sp. (cf. C. stagnalis) (unc G)

Carastium fontantum ssp. vulgare (M, P, G, B)

Digitalis purpurea (unc B)

Epilobium ciliatum (unc M, unc B)

Galium palustre ssp. palustre (unc B)

Hypericum perforatum (unc M)

Linum catharticum (M, unc B)

Lotus pedunculatus (M, unc B)

Mimulus moschatus (unc B)

Myosotis laxa ssp. caespitosa (M, unc B)

Plantago lanceolata (unc M)

P. major (unc B)

Prunella vulgaris (D, M, P, unc B)

Ranunculus repens (M, unc B)
Rumex acetosella (M, B)
R. crispus (unc B)
Sagina procumbens (M, P, G, unc B)
Stellaria media (D)
Trifolium dubium (unc M, unc B)
T. pratense (unc M)
T. repens (M, P, G, B)
Veronica serpyllifolia (M, unc B)

No. of adventive species listed for each area:

Goulard Downs (D): 3

Takaka (T) : (adventive spp. were not listed)

Matiti (M) : 52

Pike (P) : 14

Gari baldi Ridge (G) : 14

Bald Knob Ridge (B) : c. 42

RECORDS NOT ACCEPTED

Hebe matthewsii (Druce and Courtney, 1989)

H. traversii (Druce and Simpson, 1974)

H. gracillima X H. sp. (a) (Druce, Williams and Heine, 1987)

H. salicifolia X H. traversii (Druce and Simpson, 1974)

Poa nevae-zelandiae (Druce, Williams and Heine, 1987)

Epilobium pedunculare (Druce, Williams and Heine, 1987)

Euphrasia laingii (Druce, Williams and Heine, 1987)

Geranium microphyllum (Druce, Williams and Heine, 1987)

Notofkiaspi australe (Druce, Williams and Heine, 1987)

Oreomyrrhis ramosa (Druce, Williams and Heine, 1987)

APPENDIX: VOUCHER SPECIMENS FOR UNNAMED TAXA

Phyllocladus sp.(a)

Aristotalia fruticosa var.(a)

Coprosma pseudocuneata ssp.(a)

C. sp.(b)

C. sp.(c)

C. sp.(d)

C. sp.(e)

Cyathodes sp.(a)

Dracophyllum sp.(a)

Hebe haastii var.(a)

H. sp.(n)

H. sp.(r)

H. sp.(undetermined)

Helichrysum intermedium var.(a)

H. intermedium X Raoulia sp.(undetermined)

Leucopogon fasciculatus var.(a)

Melicertus sp.(a)

M. sp.(f)

Olearia nummularifolia var.(a)

Rubus cissoides var.(a)

Asplenium sp.(a)

Blechnum sp.(a)

B. sp.(b)

Agrostis sp.(b)

Chionocholea sp.(a)

Elymus sp.(a)

Festuca sp.(a)

F. sp.(b)

Koeleria sp.(a)

Poa sp.(c) (CHR 363545, 369896, 369898-9)

Trisetum sp.(a)

T. sp.(c)

I suspected hybrids between T. youngii, T. sp.(b), and T. sp.(c)

Carex sp.(a)

C. sp.(b)

C. sp.(c)

C. sp.(d)

C. sp.(e)

Uncinia fuscovaginata var.(a)

U. sp.(undetermined)

Luzula sp. (L. picta agg.)

Astelia sp.(b)

Potamogeton sp.(undetermined)

Brachyglottis lagopus var.(a)

Celmisia sp.(a) ssp.(a)

C. sp.(b)

Craspedia

Pseudognaphalium sp.(a)

P. sp.(b)

Aciphylla polita var.(a)

A. sp.(c)

Anisotome sp.(a)

Apilifera x Aciphylla sp.(undetermined)

Cardamine sp.(a)

C. sp.(b)

C. sp.(c)

C. sp.(d)

clay.

x

C. sp. (e)

C. sp. (f)

C. sp. (C. debilis agg.)

Colobanthus sp. (b)

Euphrasia sp. (e)

E. sp. (f)

Gentiana sp. (a)

G. sp. (b)

G. sp. (undetermined)

Geranium sp. (c)

Geum sp. (a)

Myosotis sp. (b)

M. sp. (undetermined)

Nartera sp. (a)

Notolthaspi sp. (b)

Oreomyrrhis sp. (d)

Ranunculus sp. (b)

x

*voucher not from

